

Dell™ E1910/E2210 Flat Panel Monitor User's Guide

[About Your Monitor](#)

[Setting Up Your Monitor](#)

[Operating Your Monitor](#)

[Troubleshooting](#)

[Appendix](#)

Notes, Cautions, Warnings



NOTE: A NOTE indicates important information that helps you make better use of your computer.



CAUTION: A CAUTION indicates potential damage to hardware or loss of data if instructions are not followed.



WARNING: A WARNING indicates a potential for property damage, personal injury, or death.

Information in this document is subject to change without notice.
© 2009 Dell Inc. All rights reserved.

Reproduction of these materials in any manner whatsoever without the written permission of Dell Inc. is strictly forbidden.

Trademarks used in this text: *Dell* and the *DELL* logo are trademarks of Dell Inc; *Microsoft* and *Windows* are either trademarks or registered trademarks of Microsoft Corporation in the United States and/or other countries; *Adobe* is a trademark of Adobe Systems Incorporated, which may be registered in certain jurisdictions. *ENERGY STAR* is a registered trademark of the U.S. Environmental Protection Agency. As an ENERGY STAR partner, Dell Inc. has determined that this product meets the ENERGY STAR guidelines for energy efficiency.

Other trademarks and trade names may be used in this document to refer to either the entities claiming the marks and names or their products. Dell Inc. disclaims any proprietary interest in trademarks and trade names other than its own.

Model E1910c/E1910f/E2210c/E2210f

July 2009 Rev. A00

[Back to Contents Page](#)

About Your Monitor

Dell™ E1910/E2210 Flat Panel Monitor User's Guide



- [Package Contents](#)
 - [Product Features](#)
 - [Identifying Parts and Controls](#)
 - [Monitor Specifications](#)
 - [Plug and Play Capability](#)
 - [LCD Monitor Quality and Pixel Policy](#)
 - [Maintenance Guidelines](#)
-

Package Contents

Your monitor ships with the components shown below. Ensure that you have received all the components and [contact Dell](#) if something is missing.

 **NOTE:** Some items may be optional and may not ship with your Monitor. Some features or media may not be available in certain countries.

	1 Monitor
	1 Stand
	1 Power Cable

	<ul style="list-style-type: none"> 1 VGA Cable
	<ul style="list-style-type: none"> 1 DVI Cable
	<ul style="list-style-type: none"> 1 Drivers and Documentation media 1 <i>Quick Setup Guide</i> 1 Safety Information

Product Features

The **Dell™ E1910** flat panel display has an active matrix, thin-film transistor (TFT), liquid crystal display (LCD). The monitor features include:

- 19-inch (482.6 mm) viewable area display.
- 1440x900 resolution, plus full-screen support for lower resolutions.
- Wide viewing angle to allow viewing from a sitting or standing position, or while moving from side-to-side.
- Tilt adjustment capabilities.
- Removable pedestal and Video Electronics Standards Association (VESA®) 100 mm mounting holes for flexible mounting solutions.
- Plug and play capability if supported by your system.
- On-Screen Display (OSD) adjustments for ease of set-up and screen optimization.
- Software and documentation media which includes an information file (INF), Image Color Matching file (ICM), and product documentation.
- Energy Saver feature for Energy Star® compliance.
- Security lock slot.
- EPEAT™ GOLD compliant.
- Halogen reduced.
- Asset Management Capability.

The **Dell™ E2210** flat panel display has an active matrix, thin-film transistor (TFT), liquid crystal display (LCD). The monitor features include:

- 22-inch (558.8 mm) viewable area display.
- 1680 x 1050 resolution, plus full-screen support for lower resolutions.
- Wide viewing angle to allow viewing from a sitting or standing position, or moving side-to-side.
- Tilt adjustment capabilities.
- Removable pedestal and Video Electronics Standards Association (VESA®) 100 mm mounting holes for flexible mounting solutions.
- Plug and play capability if supported by your system.
- On-Screen Display (OSD) adjustments for ease of set-up and screen optimization.
- Software and documentation media includes an information file (INF), Image Color Matching file (ICM), and product documentation.

- Energy Saver feature for Energy Star® compliance.
- Security lock slot.
- EPEAT™ GOLD compliant.
- Halogen reduced.
- Asset Management Capability.

Identifying Parts and Controls

Front View

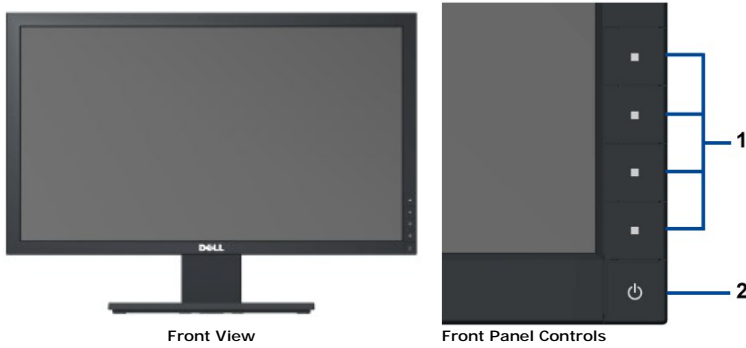

Label	Description
1.	Function buttons (For more information, see Operating the Monitor)
2.	Power On/Off button (with LED indicator)

Back View

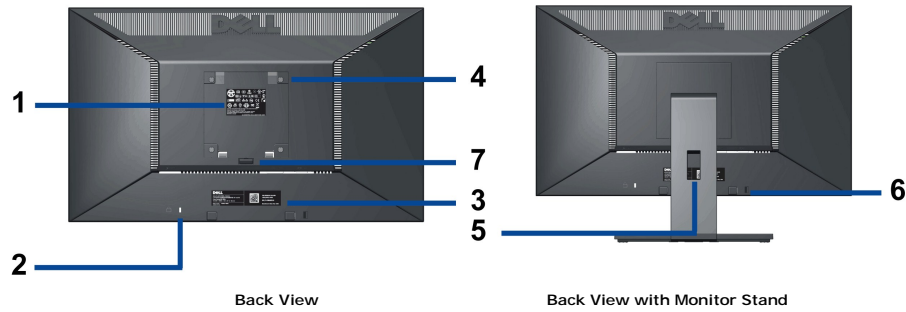

Label	Description	Use
1	Regulatory rating label	Lists the regulatory approvals.
2	Security lock slot	To help secure your monitor.
3	Barcode serial number label	To contact Dell for technical support.
4	VESA mounting holes (100mm) (Behind attached base plate)	To mount the monitor.
5	Cable management slot	To organize cables by placing them through the slot.
6	Dell Soundbar mounting brackets	To attach the optional Dell Soundbar.
7	Stand removal button	Press to release the stand.

Side View



Bottom View

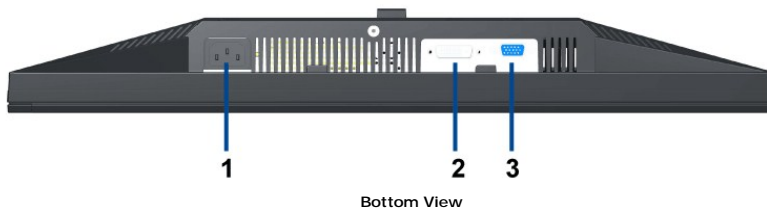

Label	Description
1	AC power cord connector
2	DVI connector
3	VGA connector

Monitor Specifications

Flat Panel Specifications

Model	Dell E1910 Flat Panel Monitor	Dell E2210 Flat Panel Monitor
Screen type	Active matrix - TFT LCD	Active matrix - TFT LCD
Panel type	TN	TN
Screen dimensions	19 inches (19-inch viewable image size)	22 inches (22-inch viewable image size)
Preset display area	408.24 (H) X 255.15 (V)	473.76 (H) x 296.1 (V)
Horizontal	408.24 mm (16.08 inches)	473.76 mm (18.65 inches)
Vertical	255.15 mm (10.05 inches)	296.1 mm (11.66 inches)
Pixel pitch	0.2835 mm	0.282 mm
Viewing angle	160° (vertical) typical, 160° (horizontal) typical	160° (vertical) typical, 170° (horizontal) typical
Luminance output	300 CD/m ² (typical)	250 CD/m ² (typical)
Contrast ratio	1000 to 1 (typical)	1000 to 1 (typical)
Faceplate coating	Antiglare with hard-coating 3H	Antiglare with hard-coating 3H
Backlight	CCFL (2) edgelight system	CCFL (2) edgelight system
Response Time	5 ms typical	5 ms typical

Color depth	16.7 millions colors	16.7 millions colors
Color Gamut	83% (typical)* CIE1976	83% (typical)* CIE1976

*[E1910/E2210] color gamut (typical) is based on CIE1976 (83%) and CIE1931 (72%) test standards.

Resolution Specifications

Model	Dell E1910 Flat Panel Monitor	Dell E2210 Flat Panel Monitor
Horizontal scan range	30 kHz to 83 kHz (automatic)	30 kHz to 83 kHz (automatic)
Vertical scan range	56 Hz to 75 Hz (automatic)	56 Hz to 75 Hz (automatic)
Maximum preset resolution	1440 X 900 at 60 Hz	1680 x 1050 at 60 Hz

Supported Video Modes

Video display capabilities (DVI playback)	480i/480p/576i/576p/720p/1080i/1080P (Supports HDCP)
---	---

Preset Display Modes

E1910

Display Mode	Horizontal Frequency (kHz)	Vertical Frequency (Hz)	Pixel Clock (MHz)	Sync Polarity (Horizontal/Vertical)
VESA, 720 x 400	31.5	70.0	28.3	-/+
VESA, 640 x 480	31.5	60.0	25.2	-/-
VESA, 640 x 480	37.5	75.0	31.5	-/-
VESA, 800 x 600	37.9	60.0	40.0	+/+
VESA, 800 x 600	46.9	75.0	49.5	+/+
VESA, 1024 x 768	48.4	60.0	65.0	-/-
VESA, 1024 x 768	60.0	75.0	78.8	+/+
VESA, 1152 x 864	67.5	75.0	108.0	+/+
VESA, 1280 x 800	49.7	60.0	83.5	-/+
VESA, 1280 x 1024	64.0	60.0	108.0	+/+
VESA, 1280 x 1024	80.0	75.0	135.0	+/+
VESA, 1440 x 900	56.0	60.0	106.5	-/+

E2210

Display Mode	Horizontal Frequency (kHz)	Vertical Frequency (Hz)	Pixel Clock (MHz)	Sync Polarity (Horizontal/Vertical)
VESA, 720 x 400	31.5	70.0	28.3	-/+
VESA, 640 x 480	31.5	60.0	25.2	-/-
VESA, 640 x 480	37.5	75.0	31.5	-/-
VESA, 800 x 600	37.9	60.0	40.0	+/+
VESA, 800 x 600	46.9	75.0	49.5	+/+
VESA, 1024 x 768	48.4	60.0	65.0	-/-
VESA, 1024 x 768	60.0	75.0	78.8	+/+
VESA, 1152 x 864	67.5	75.0	108.0	+/+
VESA, 1280 x 1024	64.0	60.0	108.0	+/+
VESA, 1280 x 1024	80.0	75.0	135.0	+/+
VESA, 1680 x 1050	65.2	60.0	146.2	-/+
VESA, 1680 x 1050-R	64.6	60.0	119.0	+/+

Electrical Specifications

Video input signals	Analog RGB, 0.7 Volts +/- 5%, positive polarity at 75 ohm input impedance Digital DVI-D TMDS, 600mV for each differential line, positive polarity at 50 ohm input impedance
Synchronization input signals	Separate horizontal and vertical synchronizations, polarity-free TTL level, SOG (Composite SYNC on green)
AC input voltage/frequency/current	100 to 240 VAC/50 or 60 Hz \pm 3 Hz/1.6A (Max.)
Inrush current	120 V: 30 A (Max.)/240 V: 60 A (Max.) (E1910) 120V:40A (Max.)/ 240V:80A (Max.) (E2210)

Physical Characteristics

Model	Dell E1910 Flat Panel Monitor	Dell E2210 Flat Panel Monitor
Connector type	15-pin D-subminiature, blue connector; DVI-D, white connector	15-pin D-subminiature, blue connector; DVI-D, white connector
Signal cable type	Digital: Detachable, DVI-D, Solid pins, shipped detached from the monitor Analog: Detachable, D-Sub, 15pins, shipped attached to the monitor	Digital: Detachable, DVI-D, Solid pins, shipped detached from the monitor Analog: Detachable, D-Sub, 15pins, shipped attached to the monitor
Dimensions (with stand)		
Height (Extended)	14.32 inches (363.74 mm)	16.01 inches (406.7 mm)
Width	17.45 inches (442.85 mm)	20.13 inches (511.2 mm)
Depth	5.78 inches (146.86 mm)	6.44 inches (163.9 mm)
Dimensions (without stand)		
Height	11.41 inches (289.75 mm)	13.15 inches (334.0 mm)
Width	17.43 inches (442.85 mm)	20.13 inches (511.2 mm)
Depth	2.32 inches (59.00 mm)	2.54 inches (64.5 mm)
Stand dimensions		
Height (Extended)	11.39 inches (289.25 mm)	12.39 inches (314.7 mm)
Width	9.88 inches (250.86 mm)	10.47 inches (265.9 mm)
Depth	5.78 inches (146.86 mm)	6.44 inches (163.7 mm)
Weight		
Weight with packaging	12.70 lbs (5.76 kg)	15.50 lbs (7.03 kg)
Weight with stand assembly and cables	11.11 lbs (5.04 kg)	13.27 lbs (6.02 kg)
Weight without stand assembly (For wall mount or VESA mount considerations - no cables)	7.91 lbs (3.59 kg)	9.70 lbs (4.40 kg)
Weight of stand assembly	2.20 lbs (1.00 kg)	2.58 lbs (1.17 kg)

Environmental Characteristics

Temperature	
Operating	5° to 40 °C (41° to 104 °F)
Non-operating	Storage: -20° to 60°C (-4° to 140°F) Shipping: -20° to 60°C (-4° to 140°F)
Humidity	
Operating	10% to 80% (non-condensing)
Non-operating	Storage: 5% to 90% (non-condensing) Shipping: 5% to 90% (non-condensing)
Altitude	
Operating	3,657.6 m (12,000 ft) max
Non-operating	12,192 m (40,000 ft) max
Thermal dissipation	95.76 BTU/hour (maximum) 75.24 BTU/hour (typical) (E1910) 106.02 BTU/hour (maximum) 95.76 BTU/hour (typical) (E2210)

[Back to Contents Page](#)

Appendix

Dell™ E1910/E2210 Flat Panel Monitor User's Guide

- [Safety Instructions](#)
- [FCC Notice \(U.S. Only\) and Other Regulatory Information](#)
- [Contacting Dell](#)



WARNING: Safety Instructions

 **WARNING:** Use of controls, adjustments, or procedures other than those specified in this documentation may result in exposure to shock, electrical hazards, and/or mechanical hazards.

For information on safety instructions, see the *Product Information Guide*.

FCC Notices (U.S. Only) and Other Regulatory Information

For FCC notices and other regulatory information, see the regulatory compliance website located at www.dell.com/regulatory_compliance.

Contacting Dell

For customers in the United States, call 800-WWW-DELL (800-999-3355).

 **NOTE:** If you do not have an active Internet connection, you can find contact information on your purchase invoice, packing slip, bill, or Dell product catalog.

Dell provides several online and telephone-based support and service options. Availability varies by country and product, and some services may not be available in your area. To contact Dell for sales, technical support, or customer service issues:

1. Visit support.dell.com.
 2. Verify your country or region in the **Choose A Country/Region** drop-down menu at the bottom of the page.
 3. Click **Contact Us** on the left side of the page.
 4. Select the appropriate service or support link based on your need.
 5. Choose the method of contacting Dell that is convenient for you.
-

[Back to Contents Page](#)

[Back to Contents Page](#)

Setting Up Your Monitor

Dell™ E1910/E2210 Flat Panel Monitor

If you have a Dell™ desktop or a Dell™ portable computer with internet access

1. Go to <http://support.dell.com>, enter your service tag, and download the latest driver for your graphics card.
2. After installing the drivers for your Graphics Adapter, attempt to set the resolution to 1440x900 (**E1910**) or 1680x1050 (**E2210**) again.

 **NOTE:** If you are unable to set the resolution to 1440x900 (**E1910**) or 1680x1050 (**E2210**), please contact Dell™ to inquire about a Graphics Adapter that supports these resolutions.

[Back to Contents Page](#)

[Back to Contents Page](#)

Setting Up Your Monitor

Dell™ E1910/E2210 Flat Panel Monitor

If you have a non Dell™ desktop, portable computer, or graphics card

1. Right-click on the desktop and click **Properties**.
2. Select the **Settings** tab.
3. Select **Advanced**.
4. Identify your graphics controller supplier from the description at the top of the window (e.g. NVIDIA, ATI, Intel etc.).
5. Refer to the graphic card provider website for updated driver (for example, <http://www.ATI.com> OR <http://www.NVIDIA.com>).
6. After installing the drivers for your Graphics Adapter, attempt to set the resolution to 1440x900 (**E1910**) or 1680x1050 (**E2210**) again.

 **NOTE:** If you are unable to set the resolution to 1440x900 (**E1910**) or 1680x1050 (**E2210**), please contact the manufacturer of your computer or consider purchasing a graphics adapter that will support the video resolution of 1440x900 (**E1910**) or 1680x1050 (**E2210**).

[Back to Contents Page](#)

Operating the Monitor

Dell™ E1910/E2210 Flat Panel Monitor User's Guide

- [Using the Front Panel Controls](#)
- [Using the On-Screen Display \(OSD\) Menu](#)
- [Setting the Maximum Resolution](#)
- [Using the Dell Soundbar \(Optional\)](#)
- [Using the Tilt](#)

Power On the Monitor

Press the  button to turn on the monitor

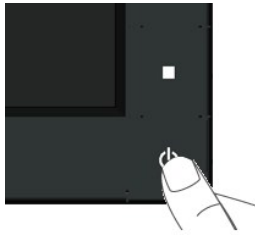

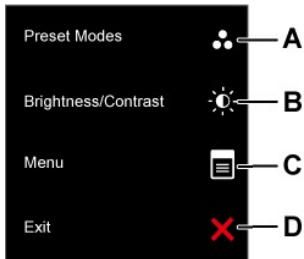
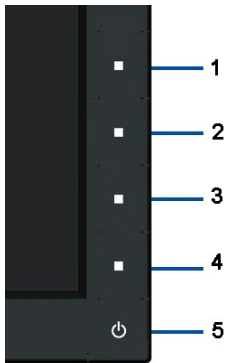

Using the Front Panel Controls

Use the keys on the front of the monitor to adjust the image settings.







Front panel Key	Description
A 	Use this button to directly access the Shortcut Key 1 (Default: Preset Modes) menu or to increase the value of the selected menu option. See Using the OSD Menu .

Preset modes		
B	 Brightness / Contrast	Use this button to directly access the Shortcut Key 2 (Default: Brightness/Contrast) menu or to decrease the value of the selected menu option.
C	 Menu	Use the Menu key to open the on-screen display(OSD).
D	 Exit	Use the Exit key to exit on-screen display(OSD) from menu and sub-menus.

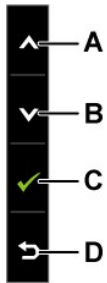
Front panel Key

[Use the keys](#) on the front of the monitor to adjust the image settings.



Front panel Key	Description
A  Up	Use the Up key to adjust (increase ranges) items in the OSD menu.
B  Down	Use the Down key to adjust (decrease ranges) items in the OSD menu.
C  OK	Use the OK key to confirm your selection.
D  Back	Use the Back key to go back to the previous menu.

Using the On-Screen Display (OSD) Menu

Accessing the Menu System







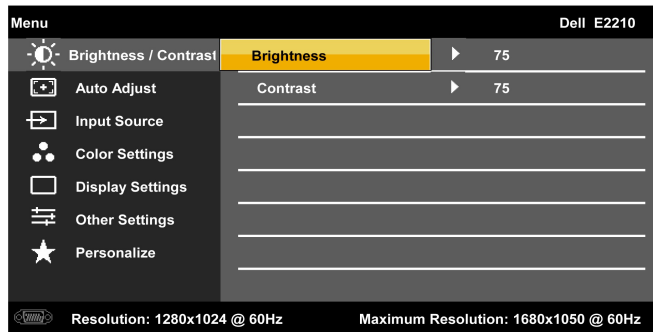
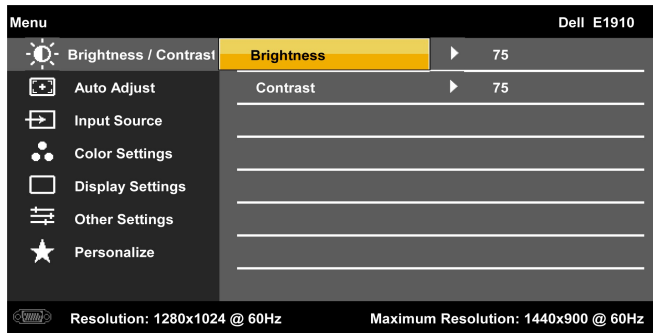



 **NOTE:** If you change the settings and then either proceed to another menu or exit the OSD menu, the monitor automatically saves those changes. The changes are also saved if you change the settings and then wait for the OSD menu to disappear.

1. Press the  button to open the OSD menu and display the main menu.

Main Menu



NOTE: Auto Adjust is only available when you are using the analog (VGA) connector.

2. Press the  and  buttons to toggle between options in the Menu. As you move from one icon to another, the option name is highlighted.
3. To select the highlighted item on the menu press the  button again.
4. Press the  and  buttons to select the desired parameter.
5. Press the  button to enter the slide bar and then use the  or  buttons, according to the indicators on the menu, to make your changes.
6. Select the  to return to previous menu without accepting current settings or  to accept and return to previous menu.

The table below provides a list of all the OSD menu options and their functions.

Icon	Menu and Submenus	Description
	Brightness/Contrast	Use the Brightness and Contrast menu to adjust the Brightness/Contrast.

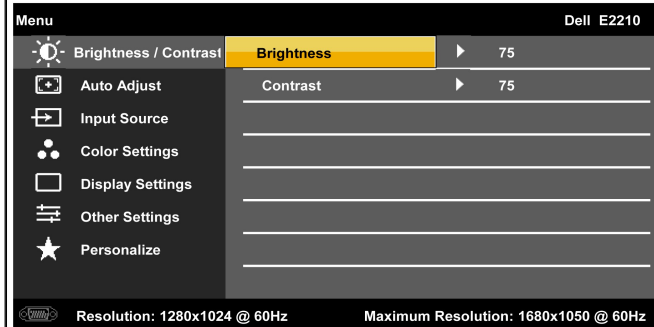
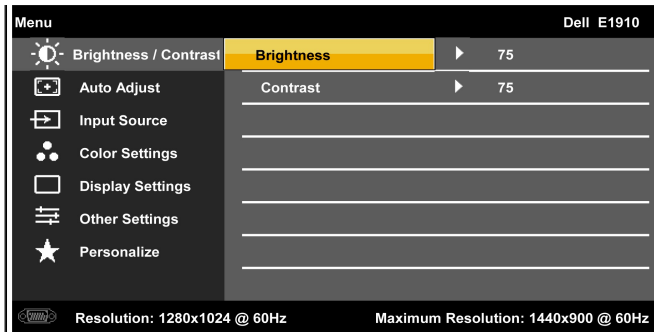



Back

Press  to go back to the main menu.



Brightness

Allows you to adjust the brightness or luminance of the backlight.

Press the  key to increase brightness and press the  key to decrease brightness (min 0 – max 100).

Contrast

Allows you to adjust the contrast or the degree of difference between darkness and lightness on the monitor screen. Adjust contrast only if you need further adjustment.

Press the  key to increase contrast and press the  key to decrease contrast (min 0 ~ max 100).

Auto Adjust



Use this key to activate automatic setup and adjust menu. The following dialog appears on a black screen as the monitor sel



Auto Adjustment allows the monitor to self-adjust to the incoming video signal. After using Auto Adjustment, you can further Pixel Clock (Coarse) and Phase (Fine) controls under Display Settings.

 **NOTE:** In most cases, Auto Adjust produces the best image for your configuration.

 **NOTE:** AUTO ADJUST option is only available when you are using the analog (VGA) connector.



Input Source

Use the **Input Source** menu to select between different video signals that may be connected to your monitor.

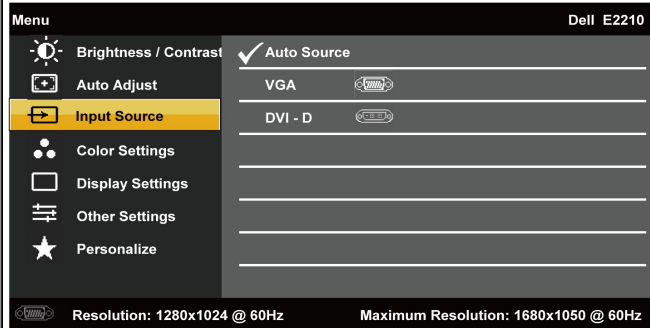
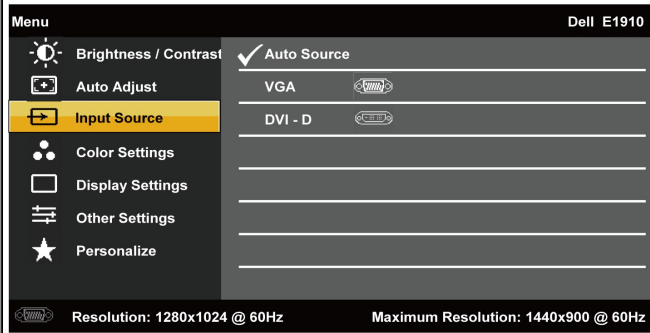

VGA

Select VGA input when you are using the analog (VGA) connector. Push to select the VGA input source.

DVI-D

Select DVI-D input when you are using the Digital (DVI) connector. Push to select the DVI input source.

Scan for Sources

Select Auto Select to scan for available input signals.



Color Settings

Use the **Color Settings** menu to adjust the monitor's color settings.

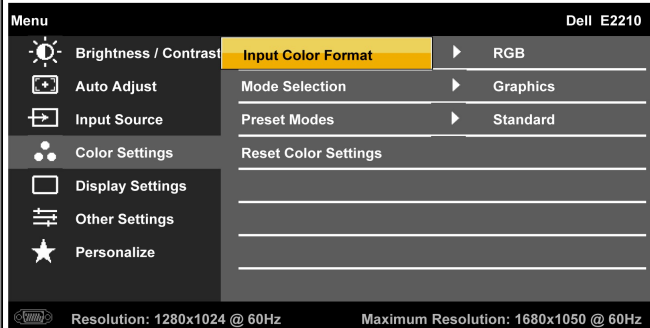
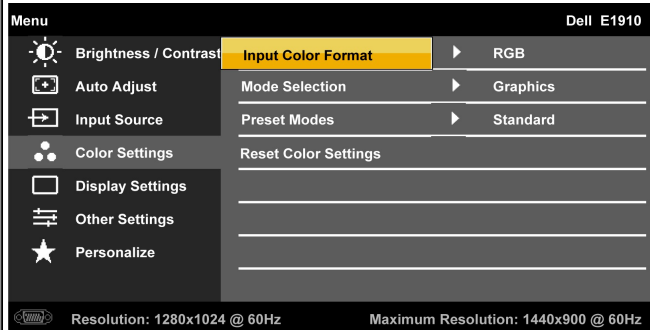

Back

Press to go back to the main menu.

Input Color Format

Allows you to set the video input mode to:

- 1 **RGB:** Select this option if your monitor is connected to a computer or DVD player using the VGA and DVI cable or the H
- 1 **YPbPr:** Select this option if your DVD player supports only YPbPr output.

Mode Selection

Allows you to set the display mode to:

- 1 **Graphics:** Select this mode if your monitor is connected to your computer.
- 1 **Video:** Select this mode if your monitor is connected to a DVD player.

NOTE: Depending upon the Display Mode you select the Preset Modes available for your monitor change.

Preset Mode

Allows you to choose from a list of preset color modes.

In the **Graphics** mode, you can set the color to the following preset values:

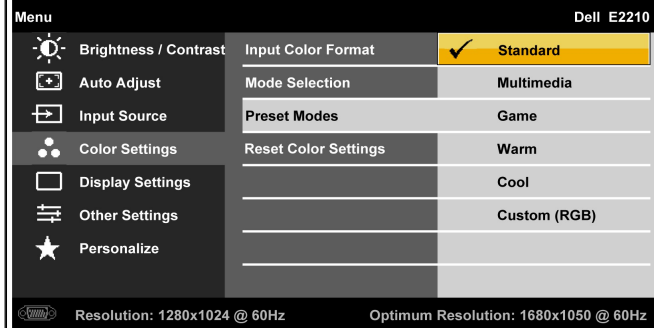
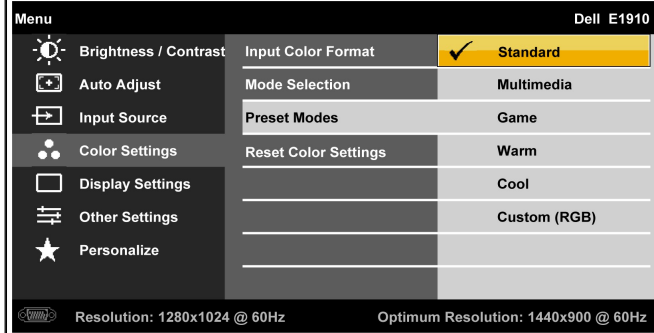

- 1 **Standard:** Loads the monitor's default color settings. This is the default preset mode.
- 1 **Multimedia:** Loads color settings ideal for multimedia applications.
- 1 **Game:** Loads color settings ideal for most gaming applications.
- 1 **Warm:** Increases the color temperature. The screen appears warmer with a red/yellow tint.
- 1 **Cool:** Decreases the color temperature. The screen appears cooler with a blue tint.
- 1 **Custom (RGB):** Allows you to manually adjust the color settings. Press the **▲** and **▼** keys to adjust the Red, Green, and Blue color settings.

In the **Video** mode, you can set the color to the following preset values:

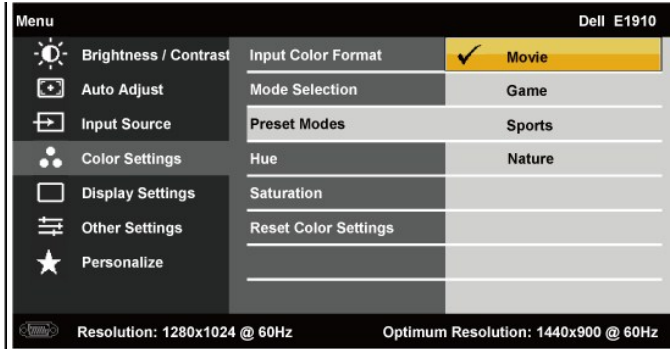

- | **Movie:** Loads color settings ideal for movies. This is the default preset mode.
- | **Game:** Loads color settings ideal for most gaming applications.
- | **Sports:** Loads color settings ideal for sports.
- | **Nature:** Loads color settings ideal for nature.

Hue

Allows you to adjust the skin tone of the image. Use ▲ or ▼ to adjust the hue from '0' to '100'.

Saturation

NOTE: Hue adjustment is available only in the **Video** mode.

Allows you to adjust the color saturation of the image. Use ▲ or ▼ to adjust the saturation from '0' to '100'.

Reset Color Settings

NOTE: Saturation adjustment is available only in the **Video** mode.

Resets your monitor's color settings to the factory defaults.



Displays Settings

Use the **Displays Settings** menu to adjust the monitor's display settings.

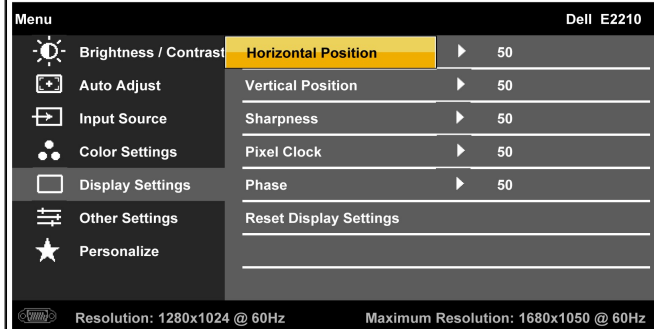
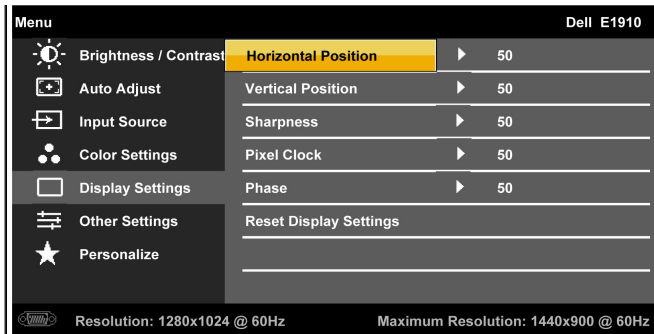

Back

Press to go back to the main menu.

Horizontal Position

Use the or buttons to adjust image left and right. Minimum is '0' (-). Maximum is '100' (+).

NOTE: When using a DVI source, the Horizontal Position setting is not available.

Vertical Position

Use the or buttons to adjust image up and down. Minimum is '0' (-). Maximum is '100' (+)

NOTE: When using a DVI source, the Vertical Position setting is not available.

Sharpness

This feature can make the image look sharper or softer. Use or to adjust the sharpness from '0' to '100'

Pixel Clock

The Phase and Pixel Clock adjustments allow you to adjust your monitor to your preference. Use or buttons to adjust

Phase

If satisfactory results are not obtained using the Phase adjustment, use the Pixel Clock (coarse) adjustment and then use Pi

NOTE: Pixel Clock and Phase Adjustments are only available for "VGA" input.

Reset Display Settings

Select this option to restore default display settings.



Other Settings

Select this option to adjust the settings of the OSD, such as, the languages of the OSD, the amount of time the menu remain

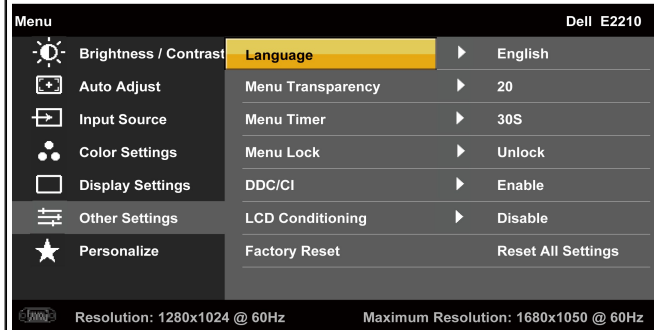
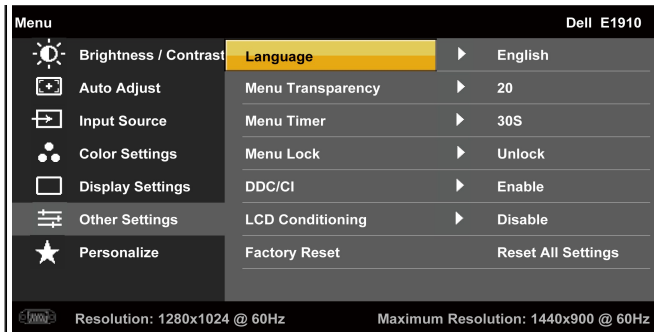

Back

Press to go back to the main menu.

Language

Allows you to set the OSD display to one of eight languages: English, Spanish, French, German, Japanese, Brazilian Portuguese

Menu Transparency

Allows you to adjust the OSD background from opaque to transparent.

Menu Timer

Allows you to set the time for which the OSD remains active after you press a key on the monitor.

Use the and keys to adjust the slider in 1 second increments, from 5 to 60 seconds.

Menu Lock

Controls user access to adjustments. When **Lock** is selected, no user adjustments are allowed. All keys are locked except . **NOTE:** When the OSD is locked, pressing the menu key takes you directly to the OSD settings menu, with 'OSD Lock' pre hold key for 15 seconds to unlock and allow user access to all applicable settings.

DDC/CI

DDC/CI (Display Data Channel/Command Interface) allows a software on your computer to adjust the monitor display setting balance etc.

Enable (Default): Optimizes the performance of your monitor and provides a better customer experience.

Disable: Disables the DDC/CI option and the following message appears on the screen.

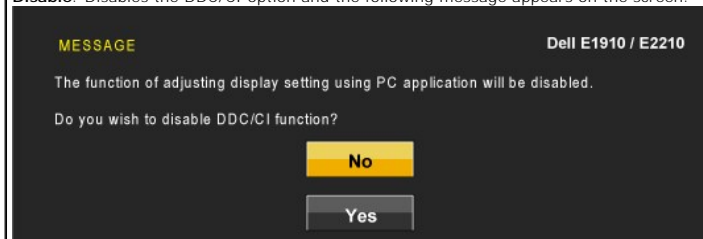



LCD Conditioning

NOTE: For best user experience and optimum performance of your monitor, keep this feature enabled.

This feature will help reduce minor cases of image retention. If an image appears to be stuck on the monitor, select LCD Conditioning. Using the LCD Conditioning feature may take some time. LCD Conditioning feature cannot remove severe cases of image retention.

NOTE: Use LCD Conditioning only when you experience a problem with image retention. The below warning message appears once user selects "Enable" LCD Conditioning.

		<div data-bbox="479 193 1182 472"> <p>MESSAGE Dell E1910/E2210</p> <p>The feature will help reduce minor cases of image retention. Depending on the degree of retention, the program may take some time to run.</p> <p>Do you wish to continue?</p> <p style="text-align: center;"> <input type="button" value="No"/> <input type="button" value="Yes"/> </p> </div> <p>Factory Reset Resets all OSD settings to the factory preset values.</p>																																										
	<p>Personalize</p>	<div data-bbox="479 655 1205 1327"> <p>Menu Dell E1910</p> <table border="1"> <tr> <td>Brightness / Contrast</td> <td>Shortcut Key 1</td> <td><input checked="" type="checkbox"/> Preset Modes</td> </tr> <tr> <td>Auto Adjust</td> <td>Shortcut Key 2</td> <td>Brightness/Contrast</td> </tr> <tr> <td>Input Source</td> <td></td> <td>Auto Adjust</td> </tr> <tr> <td>Color Settings</td> <td></td> <td>Input Source</td> </tr> <tr> <td>Display Settings</td> <td></td> <td></td> </tr> <tr> <td>Other Settings</td> <td></td> <td></td> </tr> <tr> <td>★ Personalize</td> <td></td> <td></td> </tr> </table> <p>Resolution: 1280x1024 @ 60Hz Maximum Resolution: 1440x900 @ 60Hz</p> </div> <div data-bbox="479 1003 1205 1327"> <p>Menu Dell E2210</p> <table border="1"> <tr> <td>Brightness / Contrast</td> <td>Shortcut Key 1</td> <td><input checked="" type="checkbox"/> Preset Modes</td> </tr> <tr> <td>Auto Adjust</td> <td>Shortcut Key 2</td> <td>Brightness/Contrast</td> </tr> <tr> <td>Input Source</td> <td></td> <td>Auto Adjust</td> </tr> <tr> <td>Color Settings</td> <td></td> <td>Input Source</td> </tr> <tr> <td>Display Settings</td> <td></td> <td></td> </tr> <tr> <td>Other Settings</td> <td></td> <td></td> </tr> <tr> <td>★ Personalize</td> <td></td> <td></td> </tr> </table> <p>Resolution: 1280x1024 @ 60Hz Maximum Resolution: 1680x1050 @ 60Hz</p> </div> <p>Back Press  to go back to the main menu.</p>	Brightness / Contrast	Shortcut Key 1	<input checked="" type="checkbox"/> Preset Modes	Auto Adjust	Shortcut Key 2	Brightness/Contrast	Input Source		Auto Adjust	Color Settings		Input Source	Display Settings			Other Settings			★ Personalize			Brightness / Contrast	Shortcut Key 1	<input checked="" type="checkbox"/> Preset Modes	Auto Adjust	Shortcut Key 2	Brightness/Contrast	Input Source		Auto Adjust	Color Settings		Input Source	Display Settings			Other Settings			★ Personalize		
Brightness / Contrast	Shortcut Key 1	<input checked="" type="checkbox"/> Preset Modes																																										
Auto Adjust	Shortcut Key 2	Brightness/Contrast																																										
Input Source		Auto Adjust																																										
Color Settings		Input Source																																										
Display Settings																																												
Other Settings																																												
★ Personalize																																												
Brightness / Contrast	Shortcut Key 1	<input checked="" type="checkbox"/> Preset Modes																																										
Auto Adjust	Shortcut Key 2	Brightness/Contrast																																										
Input Source		Auto Adjust																																										
Color Settings		Input Source																																										
Display Settings																																												
Other Settings																																												
★ Personalize																																												

OSD Warning Messages

When the monitor does not support a particular resolution mode you will see the following message:

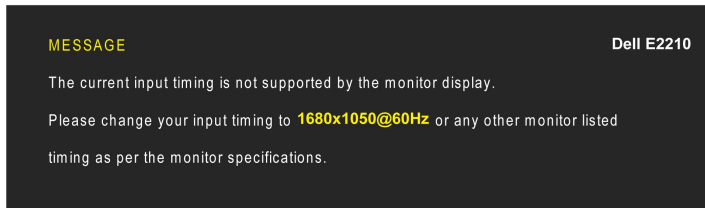
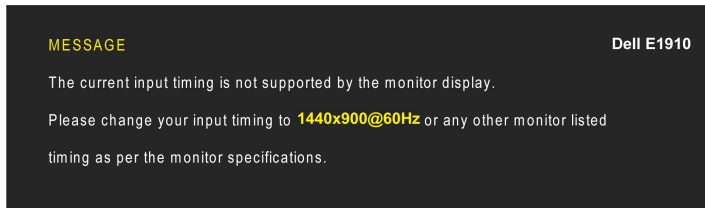

This means that the monitor cannot synchronize with the signal that it is receiving from the computer. See [Monitor Specifications](#) for the Horizontal and Vertical frequency ranges addressable by this monitor. Recommended mode is 1440x900 (E1910)/1680x1050 (E2210).

You will see the following message before the DDC/CI function is disabled.

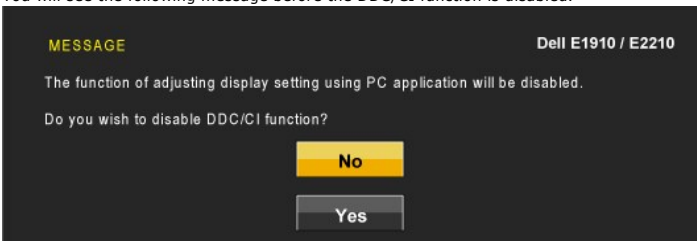

When the monitor enters the Power Save mode, the following message appears:



Activate the computer and wake up the monitor to gain access to the [OSD](#)

If you press any button other than the power button, the following messages will appear depending on the selected input:

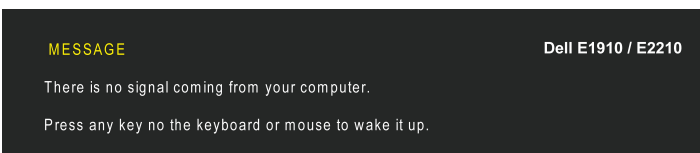

If VGA or DVI cable is not connected, a floating dialog box as shown below appears.



See [Solving Problems](#) for more information.

Setting the Maximum Resolution

To set the Maximum resolution for the monitor:

1. Right-click on the desktop and select **Properties**.
2. Select the **Settings** tab.
3. Set the screen resolution to 1440x900 (E1910) or 1680x1050 (E2210).
4. Click **OK**.

If you do not see 1440x900 (**E1910**) or 1680x1050 (**E2210**) as an option, you may need to update your graphics driver. Depending on your computer, complete one of the following procedures:

- 1 If you have a Dell desktop or portable computer:
 - o Go to **support.dell.com**, enter your service tag, and download the latest driver for your graphics card.
- 1 If you are using a non-Dell computer (portable or desktop):
 - o Go to the support site for your computer and download the latest graphic drivers.
 - o Go to your graphics card website and download the latest graphic drivers.

Using the Dell Soundbar (Optional)

The Dell Soundbar is a stereo two channel system, mountable on Dell Flat Panel Displays. The Soundbar has a rotary volume and on/off control to adjust the overall system level, a LED for power indication, and two audio headset jacks.





1.	Power/volume control
2.	Power indicator
3.	Headphone connectors

Using the Tilt

Tilt

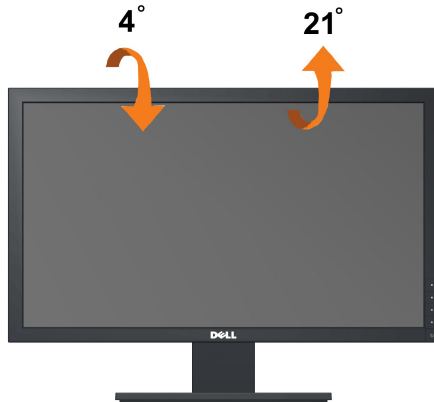
With the built-in pedestal, you can tilt the monitor for the most comfortable viewing angle.



 **NOTE:** The stand is detached when the monitor is shipped from the factory.

[Back to Contents Page](#)

Setting Up Your Monitor

Dell™ E1910/E2210 Flat Panel Monitor

Setting the display resolution to 1440x900 (E1910 Maximum) or 1680x1050 (E2210 Maximum)

For optimal display performance, while using the Microsoft Windows® operating systems, set the display resolution to 1440x900 (E1910) or 1680x1050 (E2210) pixels by performing the following steps:

1. Right-click on the desktop and click **Properties**.
2. Select the **Settings** tab.
3. Move the slider-bar to the right by pressing and holding the left mouse button and adjust the screen resolution to 1440x900 (E1910) or 1680x1050 (E2210).
4. Click **OK**.

If you do not see 1440x900 (E1910) or 1680x1050 (E2210) as an option, you may need to update your graphics driver. Please choose the scenario below that best describes the computer system you are using, and follow the provided directions:

1: [If you have a Dell™ desktop or a Dell™ portable computer with internet access.](#)

2: [If you have a non Dell™ desktop, portable computer, or graphics card.](#)

[Back to Contents Page](#)

Dell™ E1910/E2210 Flat Panel Monitor

[User Guide](#)

[Setting the display resolution to 1440x900 \(E1910 Maximum\) or 1680x1050 \(E2210 Maximum\)](#)

Information in this document is subject to change without notice.
© 2009 Dell Inc. All rights reserved.

Reproduction of these materials in any manner whatsoever without the written permission of Dell Inc. is strictly forbidden.

Trademarks used in this text: *Dell* and the *DELL* logo are trademarks of Dell Inc.; *Microsoft* and *Windows* are either trademarks or registered trademarks of Microsoft Corporation in the United States and/or other countries; *Adobe* is a trademark of Adobe Systems Incorporated, which may be registered in certain jurisdictions. *ENERGY STAR* is a registered trademark of the U.S. Environmental Protection Agency. As an ENERGY STAR partner, Dell Inc. has determined that this product meets the ENERGY STAR guidelines for energy efficiency.

Other trademarks and trade names may be used in this document to refer to either the entities claiming the marks and names or their products. Dell Inc. disclaims any proprietary interest in trademarks and trade names other than its own.

Model E1910c/E1910f/E2210c/E2210f

July 2009 Rev. A00

Setting Up the Monitor

Dell™ E1910/E2210 Flat Panel Monitor User's Guide

- [Attaching the Stand](#)
 - [Connecting the Monitor](#)
 - [Organizing Your Cables](#)
 - [Attaching the Soundbar \(optional\)](#)
 - [Removing the Stand](#)
-

Attaching the Stand

 **NOTE:** The stand is detached when the monitor is shipped from the factory.



To attach the monitor stand:

1. Remove the cover and place the monitor on it.
 2. Fit the two tabs on the upper part of the stand to the groove on the back of the monitor.
 3. Press the stand till it snaps into its place.
-

Connecting Your Monitor

 **WARNING:** Before you begin any of the procedures in this section, follow the [Safety Instructions](#).

To connect your monitor to the computer:

1. Turn off your computer and disconnect the power cable.

Connect the blue (VGA) cable from your monitor to your computer.



 **NOTE:** If your computer supports a white DVI connector, connect the white DVI cable (that ships with your monitor) to the monitor and the DVI connector on your computer.



 **NOTE:** Do not connect both the blue VGA and the white DVI cables to the computer as all monitors ship with the VGA cable attached to the monitor.

2. Connect either the white (digital DVI-D) or the blue (analog VGA) display connector cable to the corresponding video port on the back of your computer. Do not use both cables on the same computer. Use both the cables only when they are connected to two different computers with appropriate video systems.
-

Connecting the white DVI cable

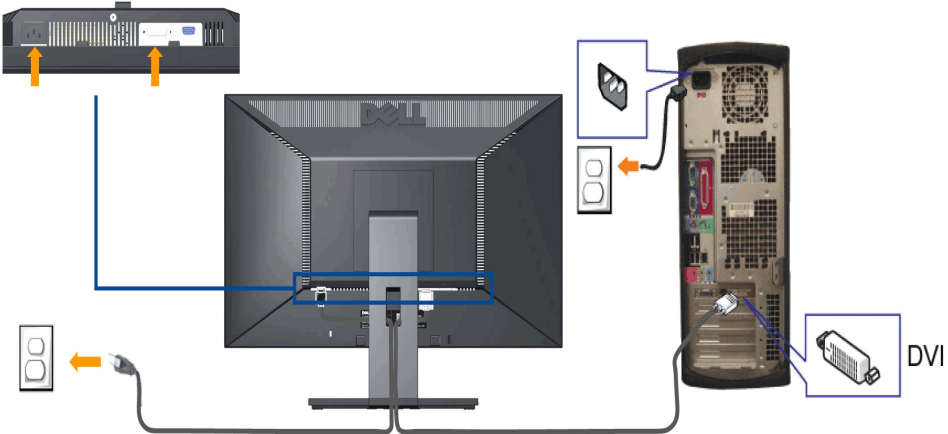

Connecting the blue VGA cable

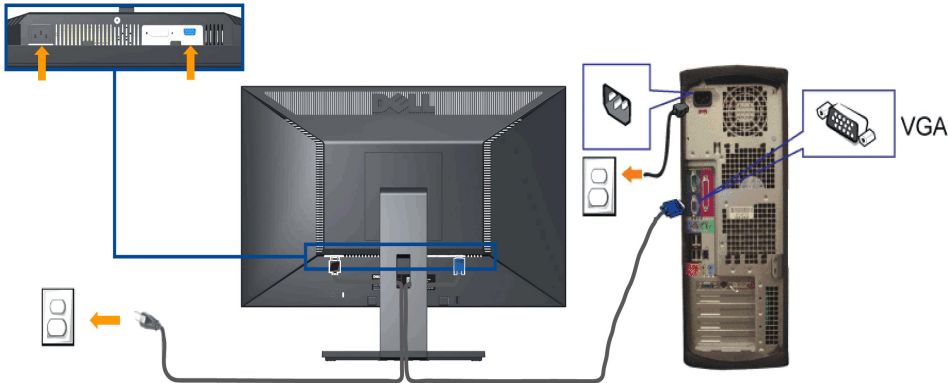

NOTE: The Graphics are used for the purpose of illustration only. Appearance of the computer may vary.

Organizing Your Cables

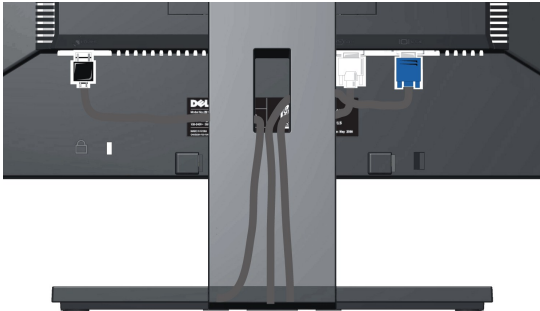

After attaching all necessary cables to your monitor and computer, (See [Connecting Your Monitor](#) for cable attachment,) use the cable management slot

to organize all cables as shown above.

Attaching the Soundbar(optional)

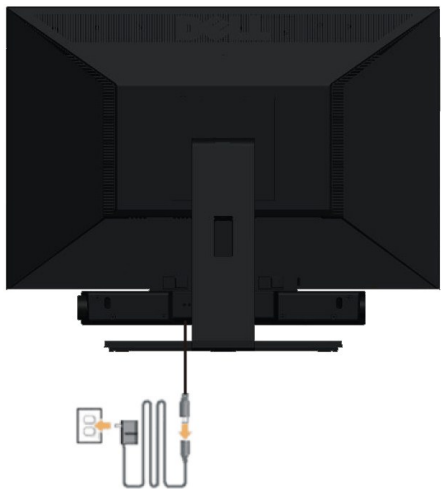

CAUTION: Do not use with any device other than Dell Soundbar.

To attach the Soundbar:

1. Working from the back of the monitor, attach Soundbar by aligning the two slots with the two tabs along the bottom of the monitor.
 2. Slide the Soundbar to the left until it snaps into place.
 3. Connect the Soundbar with the power brick.
 4. Plug the power cable of the brick to a nearby power outlet.
 5. Insert the lime-green mini stereo plug from the rear of the Soundbar into the computer's audio output jack.
-

Removing the Stand

NOTE: To prevent scratches on the LCD screen while removing the stand, ensure that the monitor is placed on a clean surface.



To remove the stand:

1. Rotate the stand to allow access to the stand release button.
 2. Press and hold the stand release button.
 3. Lift the stand up and away from the monitor.
-

Wall Mounting (Optional)

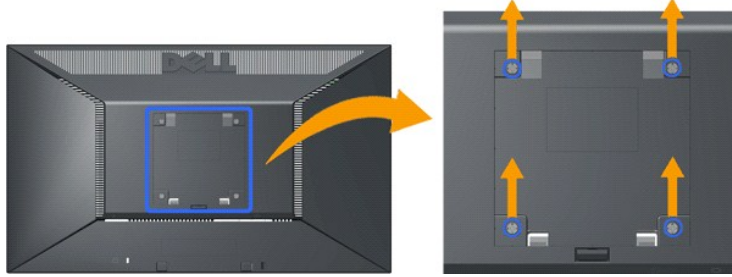

(Screw dimension: M4 x 10mm).

Refer to the instructions that come with the base mounting kit. To convert your LCD display from a desk-mounted to a wall-mounted display, do the following:

1. Verify that the power button is turned Off, then disconnect the power cord.
2. Lay the LCD display face down on a soft cloth.
3. Remove the stand assembly from the back of the LCD display by pressing quick release button.
4. Attach the mounting bracket from the VESA compatible wall mounting kit (100 mm x 100 mm distance).
5. Attach the LCD display to the wall, following the instructions in the wall-mounting kit.

 **NOTE:** For use only with UL Listed Wall Mount Bracket with minimum weight/load: 4.44kg.

[Back to Contents Page](#)

Troubleshooting

Dell™ E1910/E2210 Flat Panel Monitor

- [Self-Test](#)
- [Common Problems](#)
- [Product Specific Problems](#)
- [Dell Soundbar Problems](#)

⚠ WARNING: Before you begin any of the procedures in this section, follow the [Safety Instructions](#).

Self-Test

Your monitor provides a self-test feature that allows you to check whether your monitor is functioning properly. If your monitor and computer are properly connected but the monitor screen remains dark, run the monitor self-test by performing the following steps:

1. Turn off both your computer and the monitor.
2. Unplug the video cable from the back of the computer. To ensure proper Self-Test operation, remove both Digital (white connector) and the Analog (blue connector) cables from the back of computer.
3. Turn on the monitor.

The floating dialog box should appear on-screen (against a black background) if the monitor cannot sense a video signal and is working correctly. While in self-test mode, the power LED remains green. Also, depending upon the selected input, one of the dialogs shown below will continuously scroll through the screen.

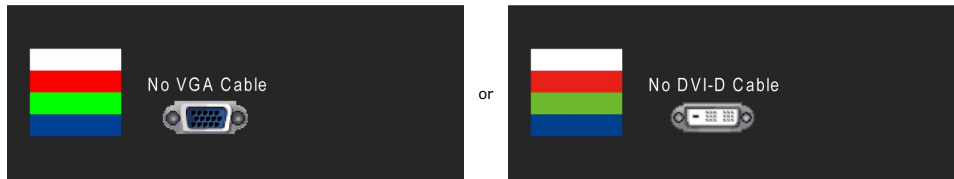

4. This box also appears during normal system operation, if the video cable becomes disconnected or damaged.
5. Turn off your monitor and reconnect the video cable; then turn on both your computer and the monitor.

If your monitor screen remains blank after you use the previous procedure, check your video controller and computer, because your monitor is functioning properly.

Built-in Diagnostics

Your monitor has a built-in diagnostic tool that helps you determine if the screen abnormality you are experiencing is an inherent problem with your monitor, or with your computer and video card.

📌 NOTE: You can run the built-in diagnostics only when the video cable is unplugged and the monitor is in *self-test mode*.

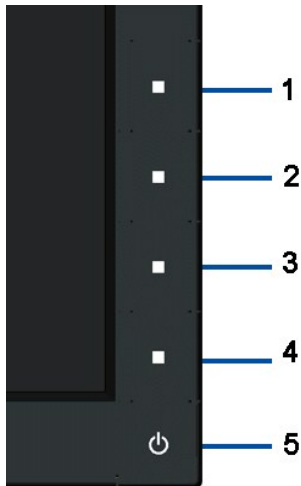

To run the built-in diagnostics:

1. Ensure that the screen is clean (no dust particles on the surface of the screen).
2. Unplug the video cable from the back of the computer or monitor. The monitor then goes into the self-test mode.
3. Press and hold the 1st and 4th buttons on the front panel, simultaneously for 2 seconds. A gray screen appears.
4. Carefully inspect the screen for abnormalities.
5. Press the 4th button on the front panel again. The color of the screen changes to red.
6. Inspect the display for any abnormalities.
7. Repeat steps 5 and 6 to inspect the display in green, blue, and white colored screens.

The test is complete when the white screen appears. To exit, press the 4th button again.

If you do not detect any screen abnormalities upon using the built-in diagnostic tool, the monitor is functioning properly. Check the video card and computer.

Common Problems

The following table contains general information about common monitor problems you might encounter and the possible solutions.

Common Symptoms	What You Experience	Possible Solutions
No Video/Power LED off	No picture	<ul style="list-style-type: none"> 1 Ensure that the video cable connecting the monitor and the computer is properly connected and secure. 1 Verify that the power outlet is functioning properly using any other electrical equipment. 1 Ensure that the power button is depressed fully.
No Video/Power LED on	No picture or no brightness	<ul style="list-style-type: none"> 1 Increase brightness & contrast controls via OSD. 1 Perform monitor self-test feature check. 1 Check for bent or broken pins in the video cable connector. 1 Run the built-in diagnostics.
Poor Focus	Picture is fuzzy, blurry, or ghosting	<ul style="list-style-type: none"> 1 Perform Auto Adjust via OSD. 1 Adjust the Phase and Pixel Clock controls via OSD. 1 Eliminate video extension cables. 1 Reset the monitor to Factory Settings. 1 Change the video resolution to the correct aspect ratio (16:10).
Shaky/Jittery Video	Wavy picture or fine movement	<ul style="list-style-type: none"> 1 Perform Auto Adjust via OSD. 1 Adjust the Phase and Pixel Clock controls via OSD. 1 Reset the monitor to Factory Settings. 1 Check environmental factors. 1 Relocate the monitor and test in another room.
Missing Pixels	LCD screen has spots	<ul style="list-style-type: none"> 1 Cycle power on-off. 1 Pixel that is permanently off is a natural defect that can occur in LCD technology. 1 Run the built-in diagnostics.
Stuck-on Pixels	LCD screen has bright spots	<ul style="list-style-type: none"> 1 Cycle power on-off. 1 Pixel that is permanently off is a natural defect that can occur in LCD technology. 1 Run the built-in diagnostics.
Brightness Problems	Picture too dim or too bright	<ul style="list-style-type: none"> 1 Reset the monitor to Factory Settings. 1 Auto Adjust via OSD. 1 Adjust brightness & contrast controls via OSD.
Geometric Distortion	Screen not centered correctly	<ul style="list-style-type: none"> 1 Reset the monitor to Factory Settings. 1 Auto Adjust via OSD. 1 Adjust brightness & contrast controls via OSD. <p>NOTE: When using '2: DVI-D', the positioning adjustments are not available.</p>

Horizontal/Vertical Lines	Screen has one or more lines	<ul style="list-style-type: none"> 1 Reset the monitor to Factory Settings. 1 Perform Auto Adjust via OSD. 1 Adjust Phase and Pixel Clock controls via OSD. 1 Perform monitor self-test feature check and determine if these lines are also in self-test mode. 1 Check for bent or broken pins in the video cable connector. 1 Run the built-in diagnostics. <p>NOTE: When using '2: DVI-D', the Pixel Clock and Phase adjustments are not available.</p>
Synchronization Problems	Screen is scrambled or appears torn	<ul style="list-style-type: none"> 1 Reset the monitor to Factory Settings. 1 Perform Auto Adjust via OSD. 1 Adjust Phase and Pixel Clock controls via OSD. 1 Perform monitor self-test feature check to determine if the scrambled screen appears in self-test mode. 1 Check for bent or broken pins in the video cable connector. 1 Restart the computer in the <i>safe mode</i>.
Safety Related Issues	Visible signs of smoke or sparks	<ul style="list-style-type: none"> 1 Do not perform any troubleshooting steps. 1 Contact Dell immediately.
Intermittent Problems	Monitor malfunctions on & off	<ul style="list-style-type: none"> 1 Ensure that the video cable connecting the monitor to the computer is connected properly and is secure. 1 Reset the monitor to Factory Settings. 1 Perform monitor self-test feature check to determine if the intermittent problem occurs in self-test mode.
Missing Color	Picture missing color	<ul style="list-style-type: none"> 1 Perform monitor self-test feature check. 1 Ensure that the video cable connecting the monitor to the computer is connected properly and is secure. 1 Check for bent or broken pins in the video cable connector.
Wrong Color	Picture color not good	<ul style="list-style-type: none"> 1 Change the Color Setting Mode in the Color Settings OSD to Graphics or Video depending on the application. 1 Try different Color Preset Settings in Color Settings OSD. Adjust R/G/B value in Color Settings OSD if the Color Management is turned off. 1 Change the Input Color Format to PC RGB or YPbPr in the Advance Setting OSD. 1 Run the built-in diagnostics.
Image retention from a static image left on the monitor for a long period of time	Faint shadow from the static image displayed appears on the screen	<ul style="list-style-type: none"> 1 Use the Power Management feature to turn off the monitor at all times when not in use (for more information, see Power Management Modes). 1 Alternatively, use a dynamically changing screensaver.

Product Specific Problems

Specific Symptoms	What You Experience	Possible Solutions
Screen image is too small	Image is centered on screen, but does not fill entire viewing area	<ul style="list-style-type: none"> 1 Reset the monitor to Factory Settings.
Cannot adjust the monitor with the buttons on the front panel	OSD does not appear on the screen	<ul style="list-style-type: none"> 1 Turn off the monitor, unplug the power cord, plug back, and then turn on the monitor.
The picture does not fill the entire screen.	The picture cannot fill the height or width of the screen	<ul style="list-style-type: none"> 1 Due to different video formats (aspect ratio) of DVDs, the monitor may display in full screen. 1 Run the built-in diagnostics.

 **NOTE:** When choosing DVI-D mode, the **Auto Adjust** function is not available.

Dell™ Soundbar Problems

Common Symptoms	What You Experience	Possible Solutions
No sound for system where the Soundbar draws power from an AC adapter	No power to Soundbar - the power indicator is off	<ul style="list-style-type: none"> 1 Turn the Power/Volume knob on the Soundbar clockwise to the middle position; check if the power indicator (green LED) on the front of the Soundbar is illuminated. 1 Confirm that the power cable from the Soundbar is plugged into the adapter.
No Sound	Soundbar has power - power indicator is on	<ul style="list-style-type: none"> 1 Plug the audio line-in cable into the computer's audio out jack. 1 Set all volume controls to their maximum and ensure that the mute option is not enabled. 1 Play some audio content on the computer (example, audio CD, or MP3). 1 Turn the Power/Volume knob on the Soundbar clockwise to a higher volume setting. 1 Clean and reseal the audio line-in plug. 1 Test the Soundbar using another audio source (For example: portable CD player, MP3 player).
Distorted Sound	Computer's sound card is used as the audio source	<ul style="list-style-type: none"> 1 Clear any obstructions between the Soundbar and the user. 1 Confirm that the audio line-in plug is completely inserted into the jack of the sound card. 1 Set all Windows volume controls to their midpoints. 1 Decrease the volume of the audio application. 1 Turn the Power/Volume knob on the Soundbar counter-clockwise to a lower volume setting. 1 Clean and reseal the audio line-in plug. 1 Troubleshoot the computer's sound card. 1 Test the Soundbar using another audio source (For example: portable CD player, MP3 player).

		<ul style="list-style-type: none"> 1 Avoid using an audio cable extension or audio jack converter.
Distorted Sound	Other audio source is used	<ul style="list-style-type: none"> 1 Clear any obstructions between the Soundbar and the user. 1 Confirm that the audio line-in plug is completely inserted into the jack of the audio source. 1 Decrease the volume of the audio source. 1 Turn the Power/Volume knob on the Soundbar counter-clockwise to a lower volume setting. 1 Clean and reseal the audio line-in plug.
Unbalanced Sound Output	Sound from only one side of Soundbar	<ul style="list-style-type: none"> 1 Clear any obstructions between the Soundbar and the user. 1 Confirm that the audio line-in plug is completely inserted into the jack of the sound card or audio source. 1 Set all Windows audio balance controls (L-R) to their midpoints. 1 Clean and reseal the audio line-in plug. 1 Troubleshoot the computer's sound card. 1 Test the Soundbar using another audio source (For example: portable CD player, MP3 player).
Low Volume	Volume is too low	<ul style="list-style-type: none"> 1 Clear any obstructions between the Soundbar and the user. 1 Turn the Power/Volume knob on the Soundbar clockwise to the maximum volume setting. 1 Set all Windows volume controls to their maximum. 1 Increase the volume of the audio application. 1 Test the Soundbar using another audio source (For example: portable CD player, MP3 player)

[Back to Contents Page](#)